

# RESTRAP

TECHNICAL BIKEPACKING GEAR

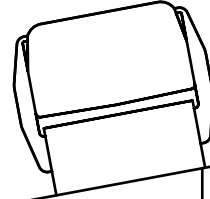

- Print this document on US Letter paper (8.5x11in) making sure that it is at 100% scale.
- Measure both sides of the crossed needles to verify the scale is accurate.
- Assemble the prints according to the numbered guide on each sheet, ensuring the registration marks lay on top of each other.
- Tape the sheets together, then cut along the bag's outline for a physical representation of our bag's shape and size.

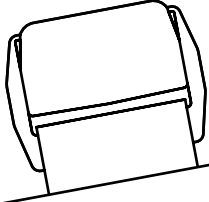
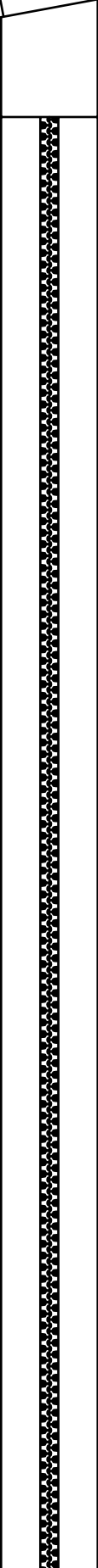
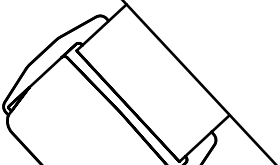
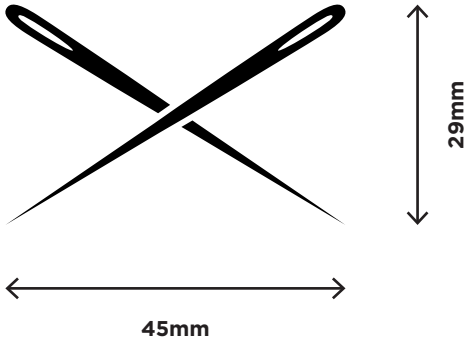

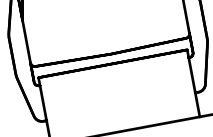

RESTRAP

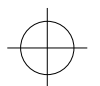
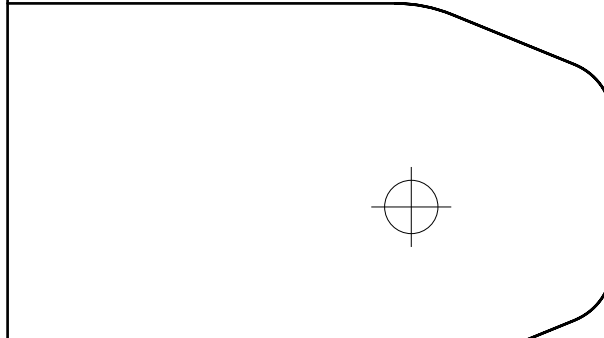
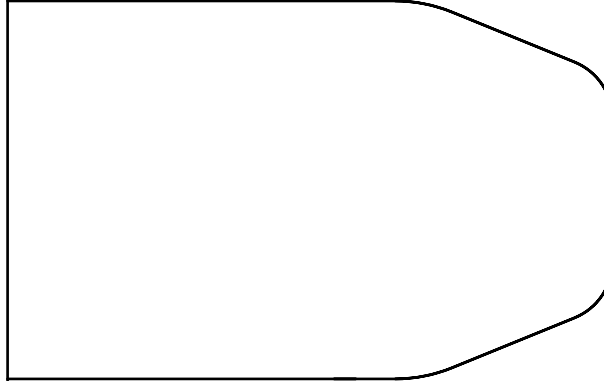

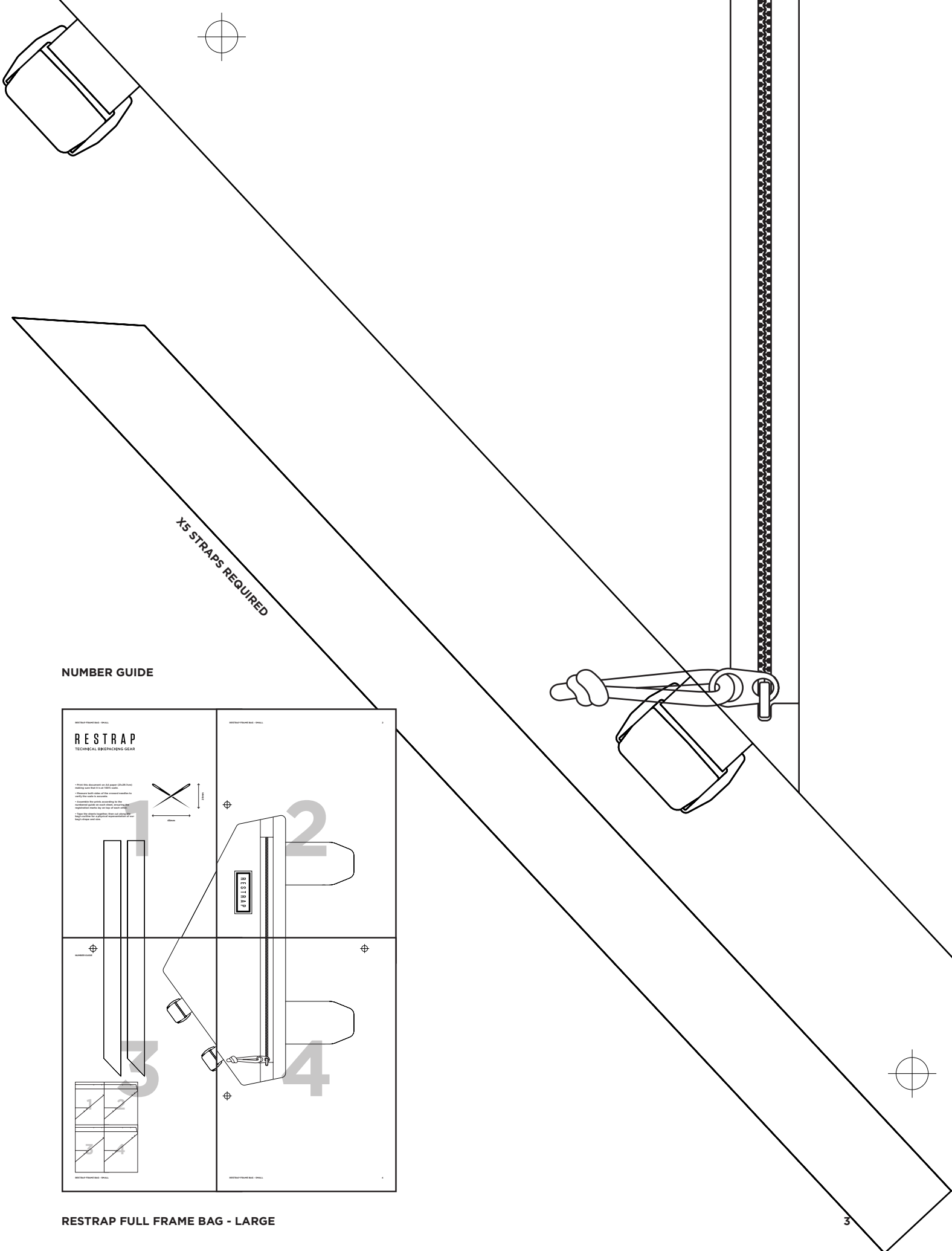

X5 STRAPS REQUIRED

NUMBER GUIDE

